

SAP Table Relations

version 1.0.0

compiled by
Christopher Solomon
with
contributions by
various SAP Professionals

How to use this document?

This document displays and describes the relationships and links between the various SAP database tables. These relationships are displayed graphically as described below:

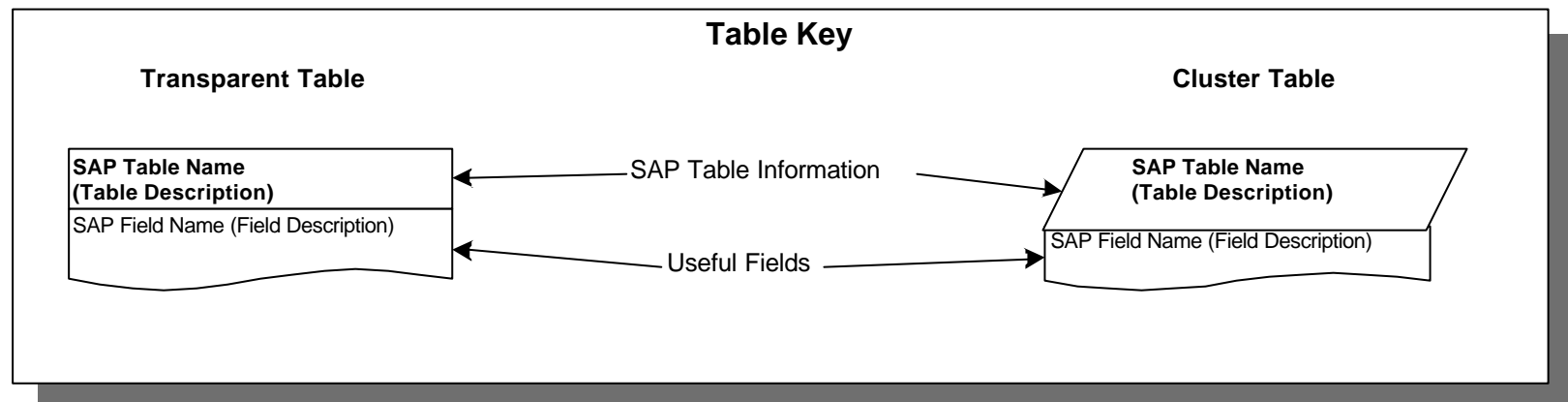

Link Key

One-to-One

One ————— One

One-to-Many

One —————> Many

Master Data Tables

CEPC = Profit Center Master Data Table

CSKS = Cost Center Master

KNA1 = Customer Master (General Data)

LFA1 = Vendor Master (General Data)

MARA = Material Master (General Data)

SKB1 = G/L Account Master (Company Code)

T001W = Plants/Branches

T001 = Company Codes

SAP - FI/CO

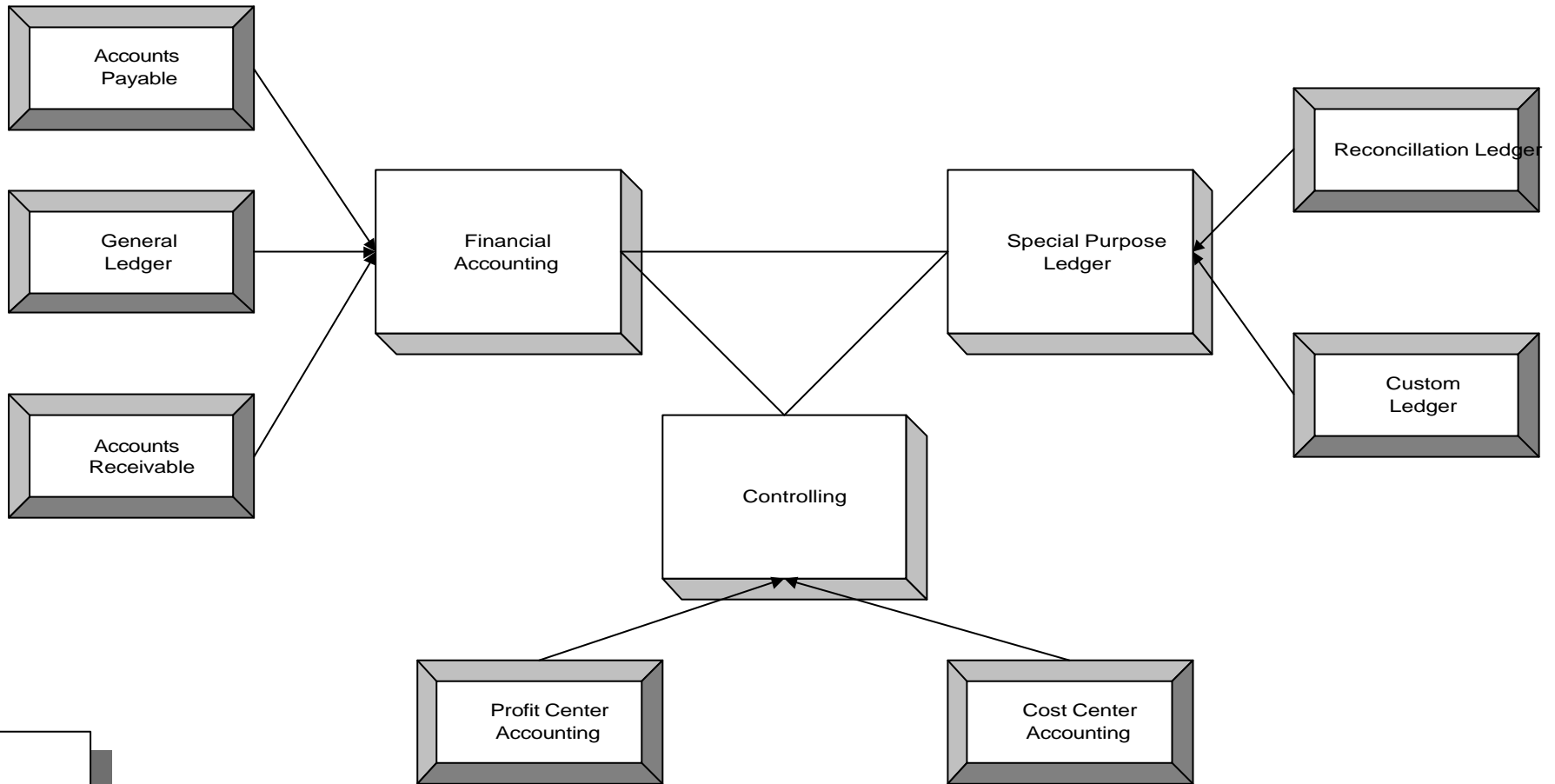

Tables:

BSAD
BSAS
BSEG
BSES
BSIK
BSIS

FI/CO

Table Mapping

SAP F/CO

Financial Accounting

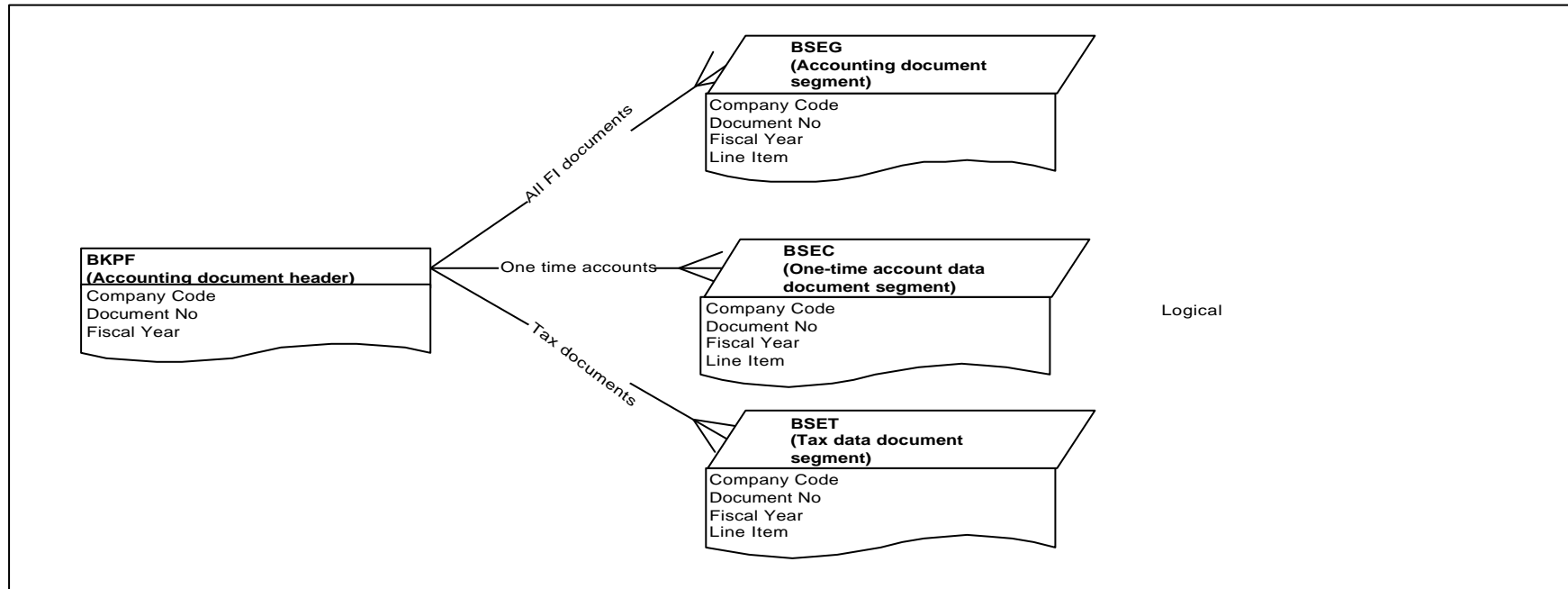
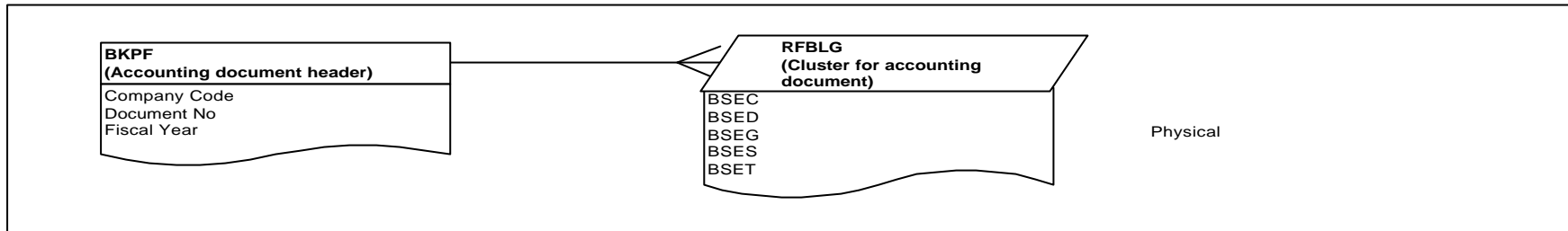

SAP FI/CO

Controlling

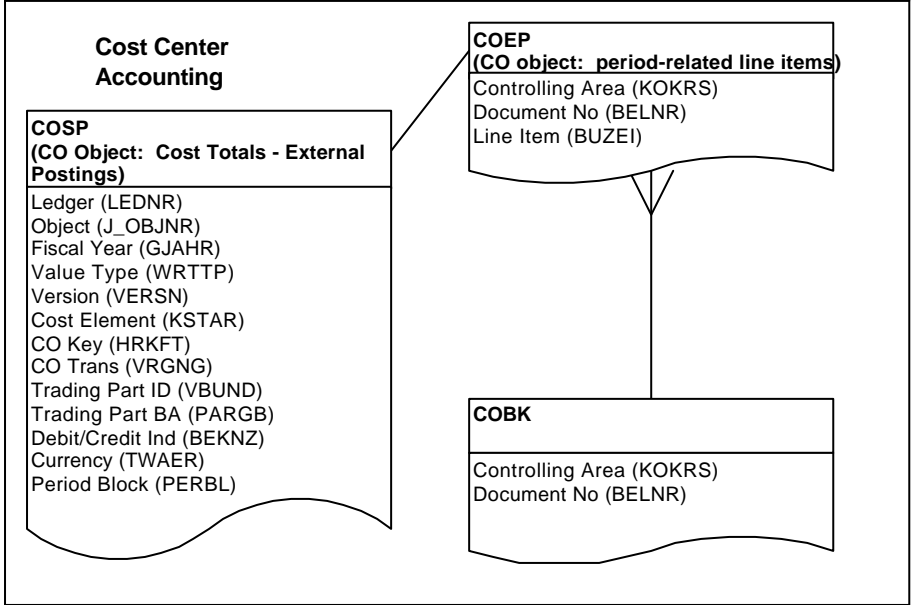
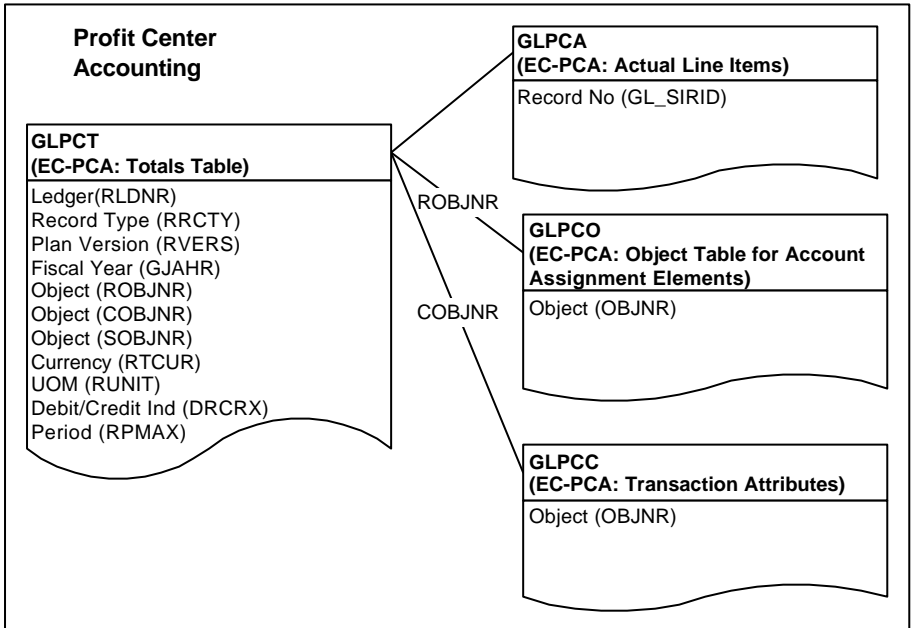

Special Purpose Ledger

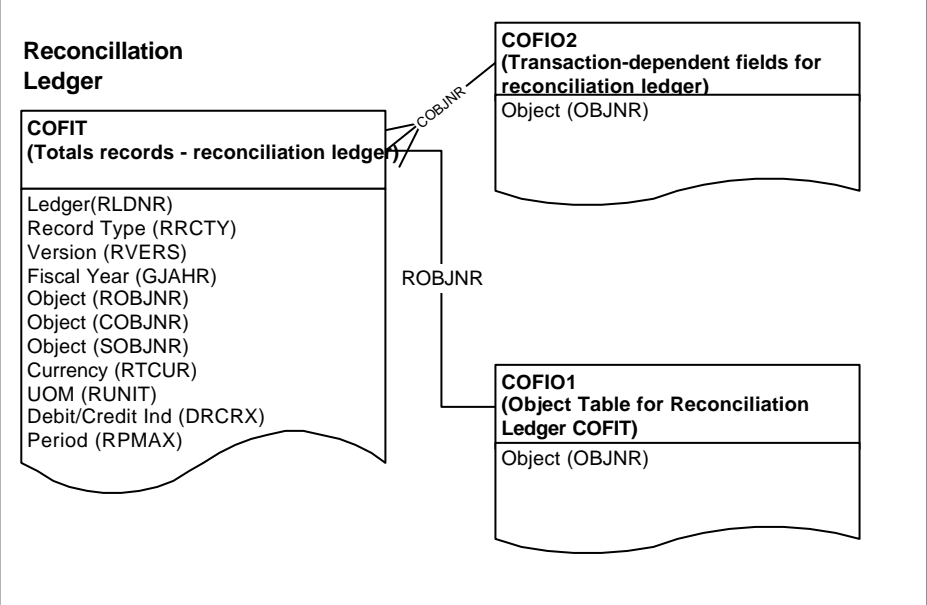
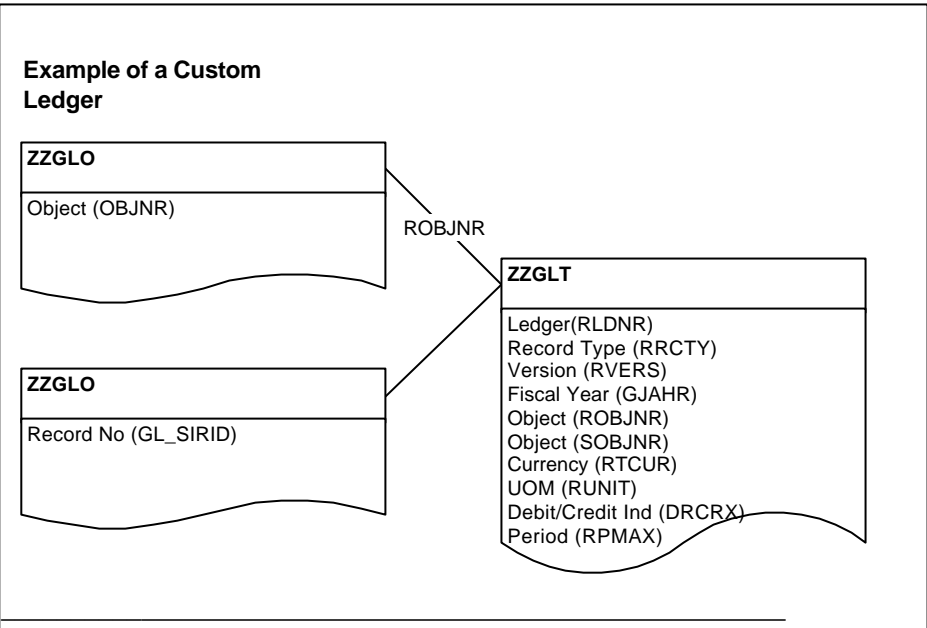

SAP FI/CO

Accounts Payable

Vendor Master Data

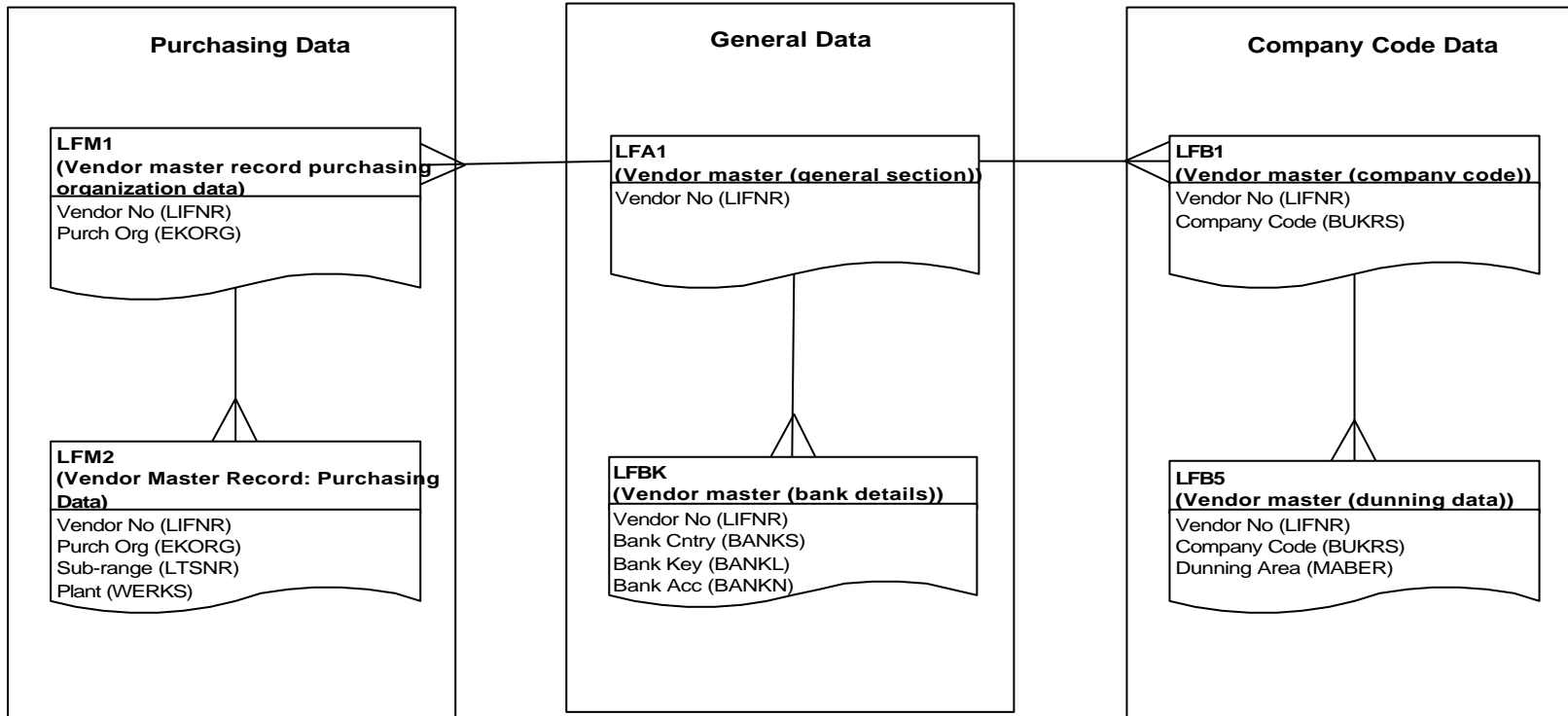

SAP FI/CO

Accounts Receivable

Customer Master Data

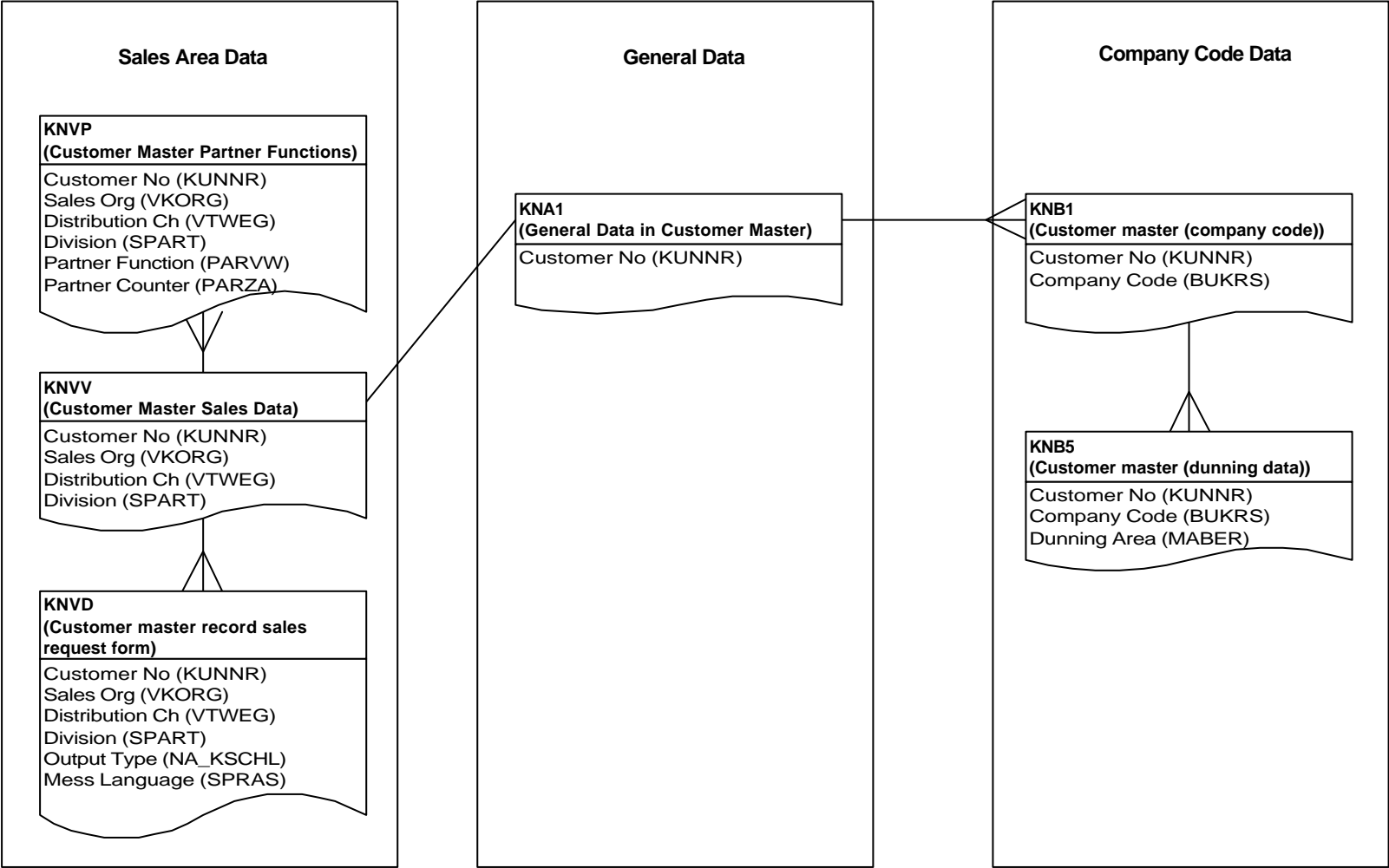

SAP FI/CO

Master Data

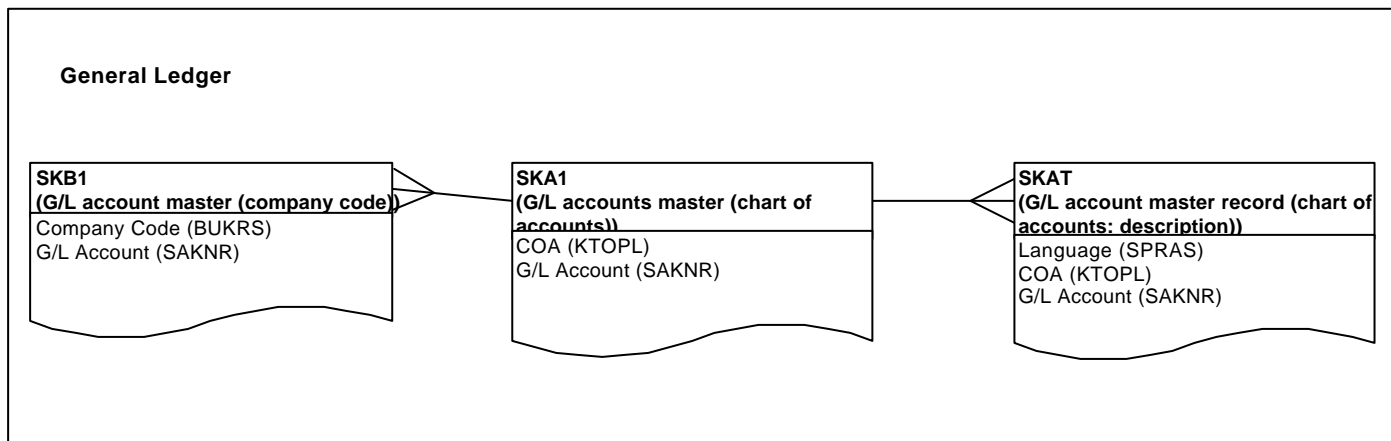
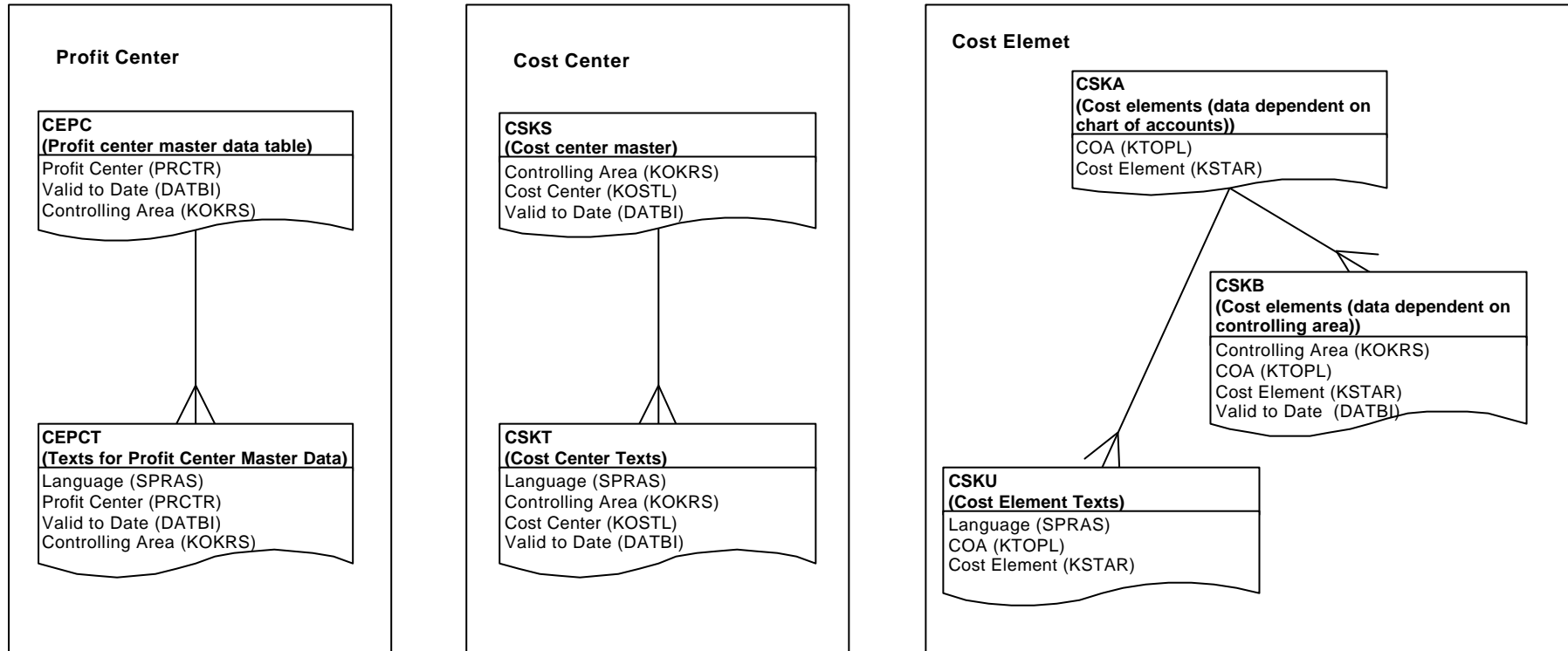

SAP - Materials Management

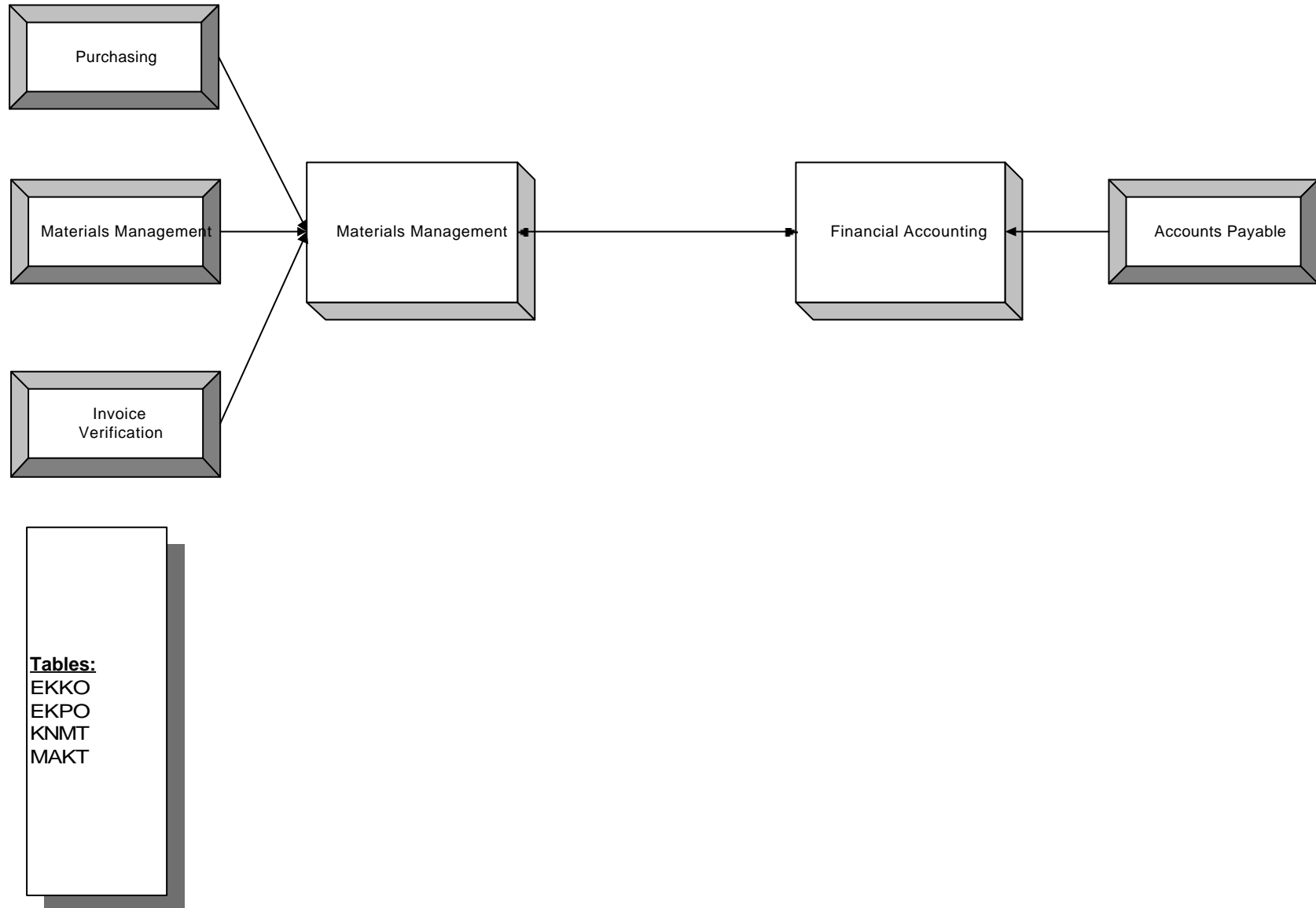

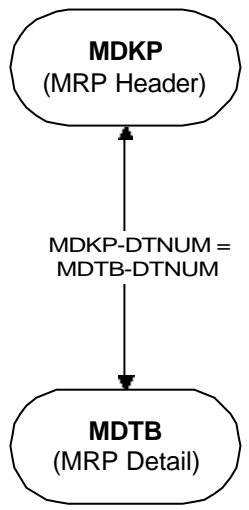
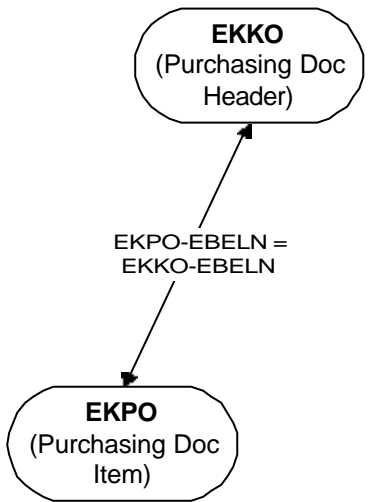
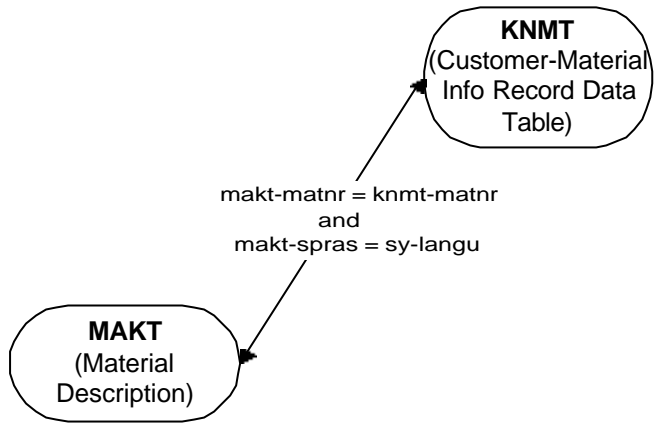

MM
Table Mapping

SAP MM - Purchasing

Purchasing Requisition

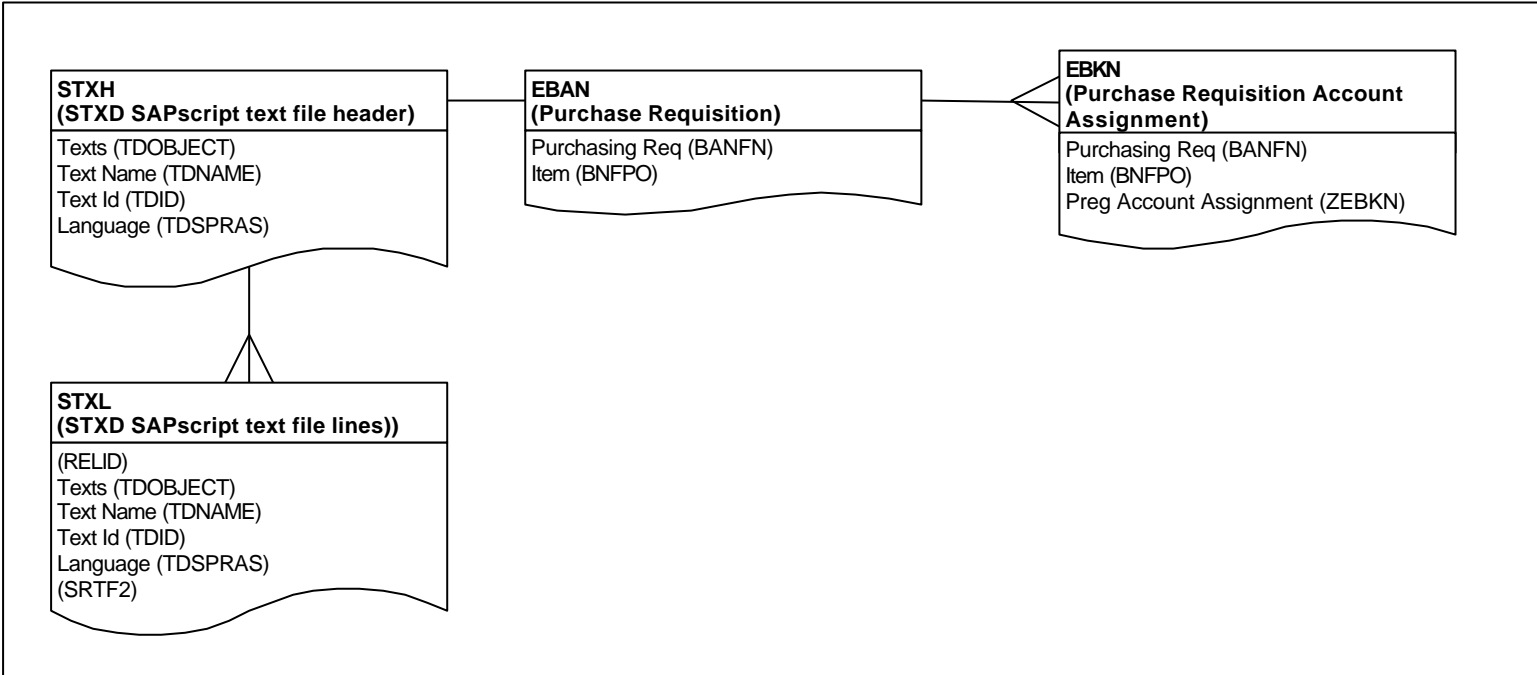

SAP MM - Purchasing

Purchase Orders

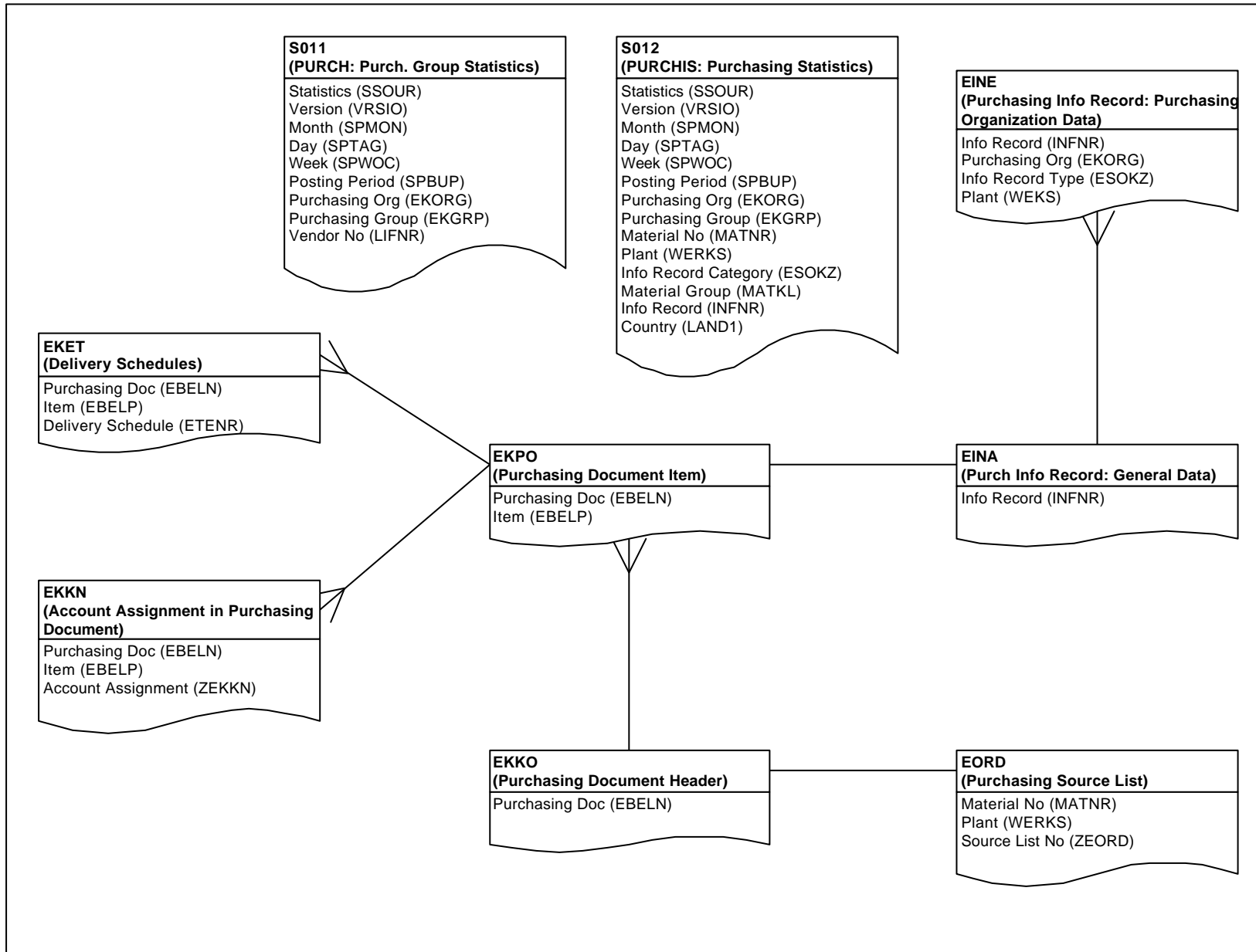

SAP MM - Purchasing

Goods Receipt

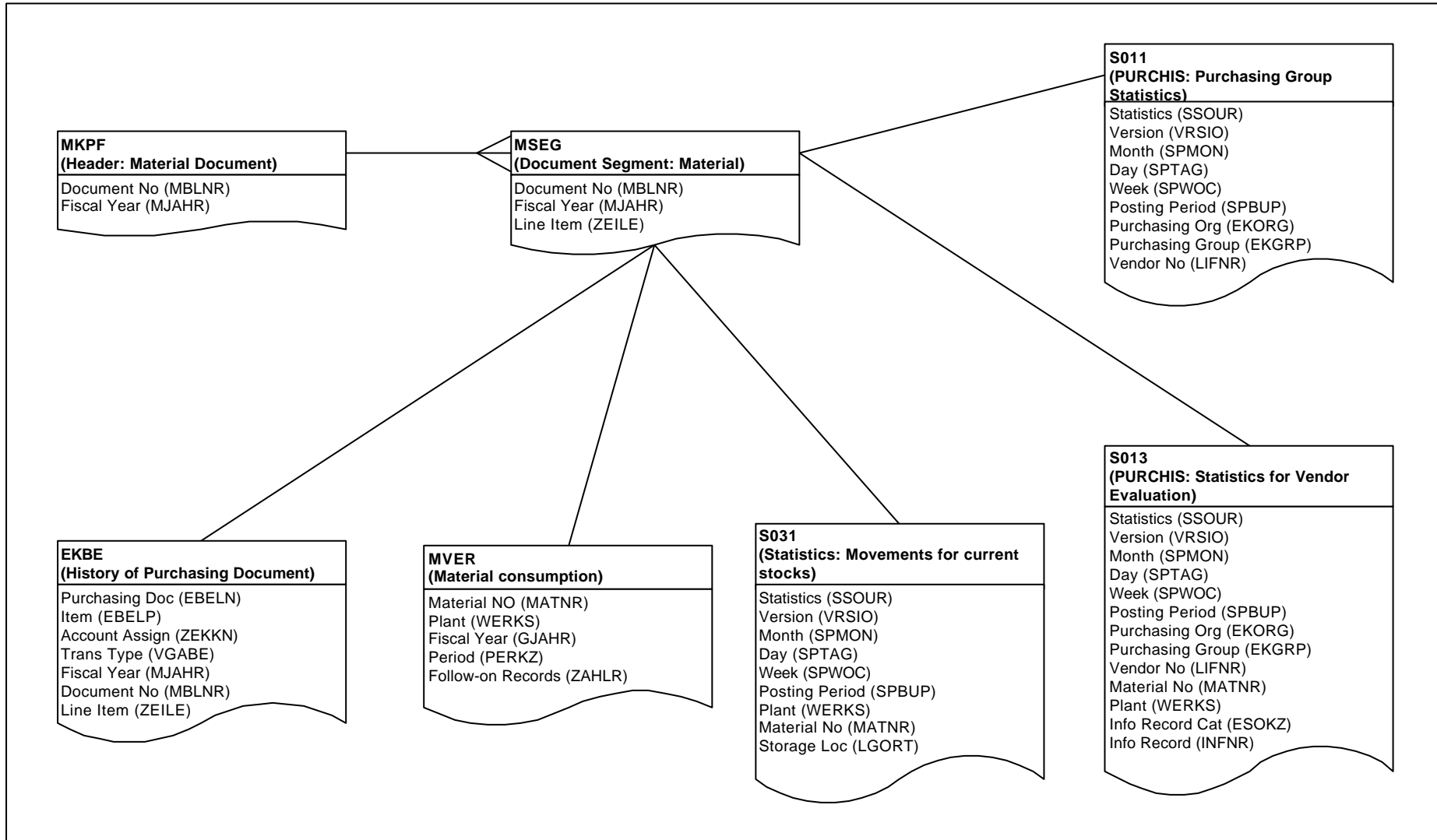

SAP MM - Master Data

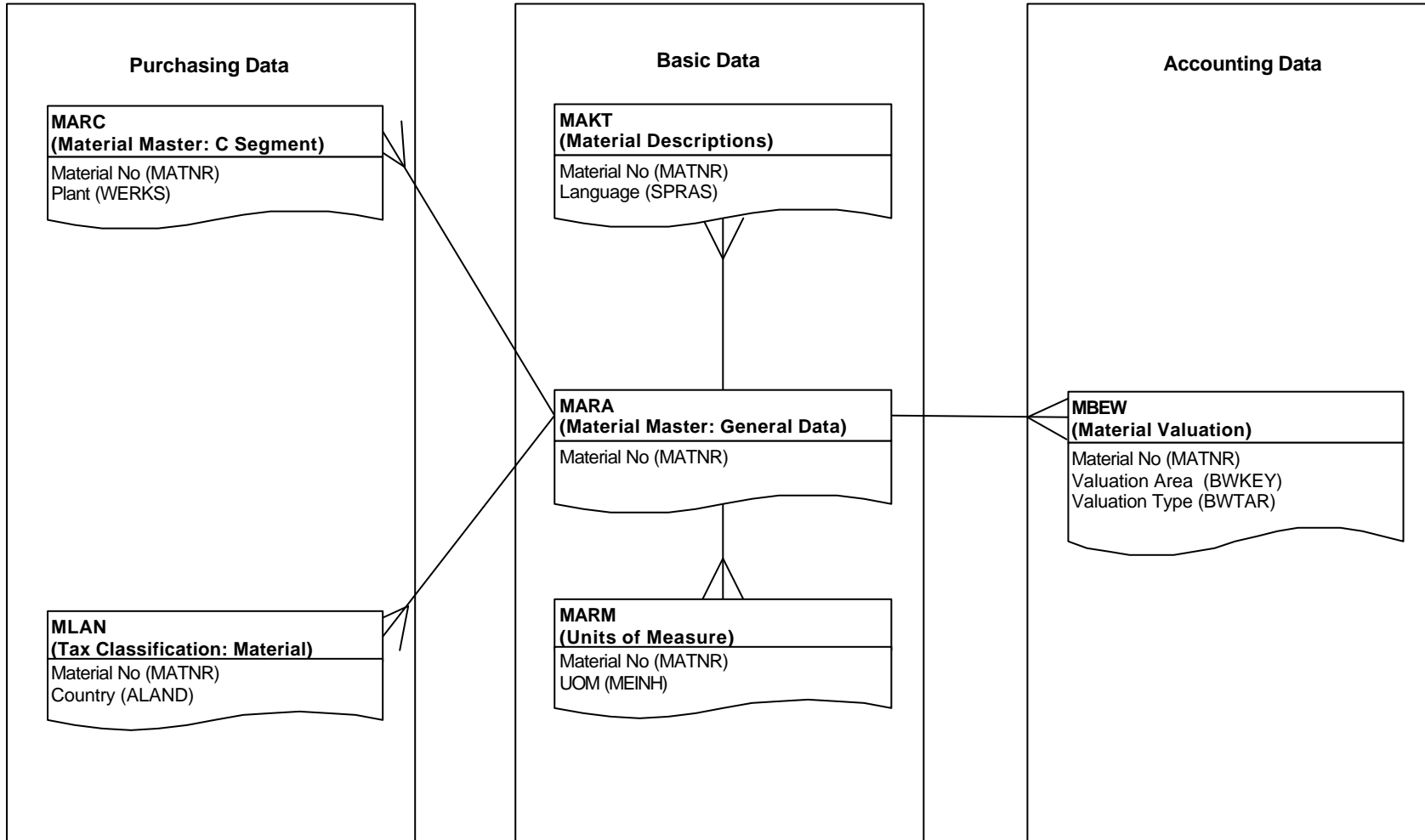

SAP MM - Purchasing

Purchasing Info Record

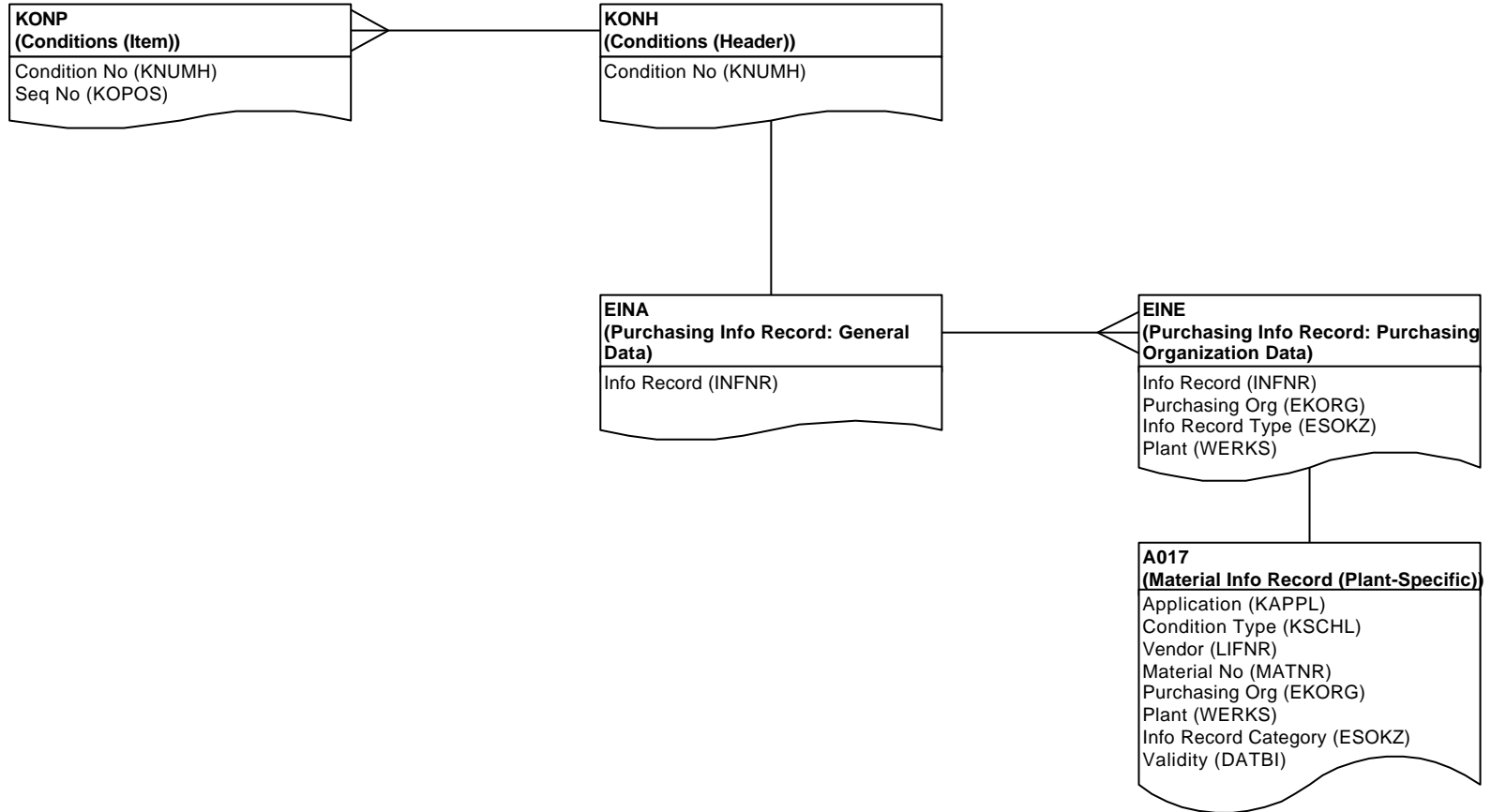

SAP - Project Planning

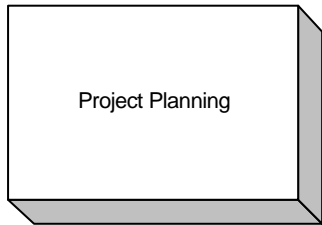

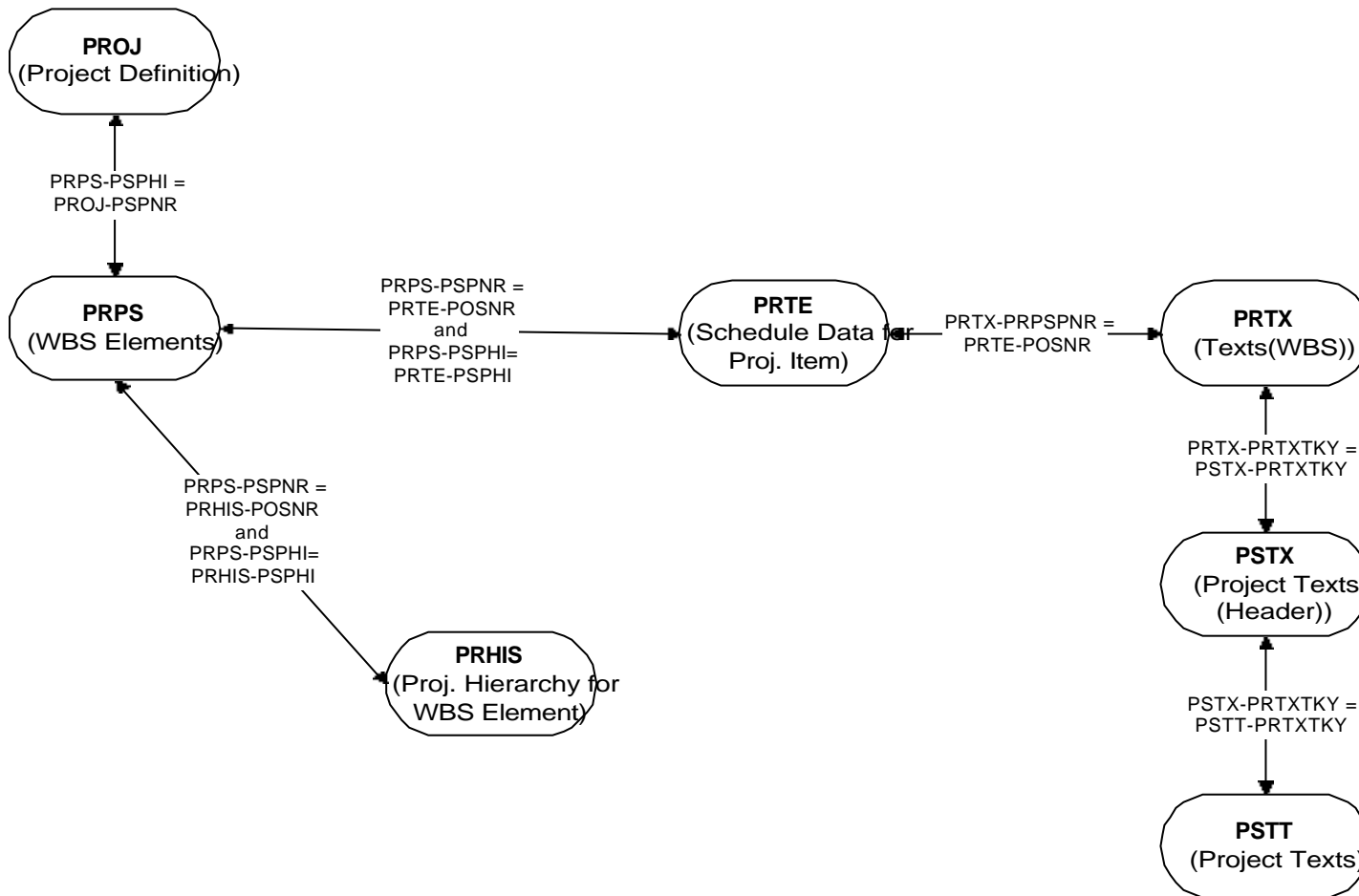

PP
Table Mapping

SAP PP - Project Planning

PROJECTS
Project and WBS element numbers have a domain with a conversion function module which converts it from 8 numc input to 24 char on output.

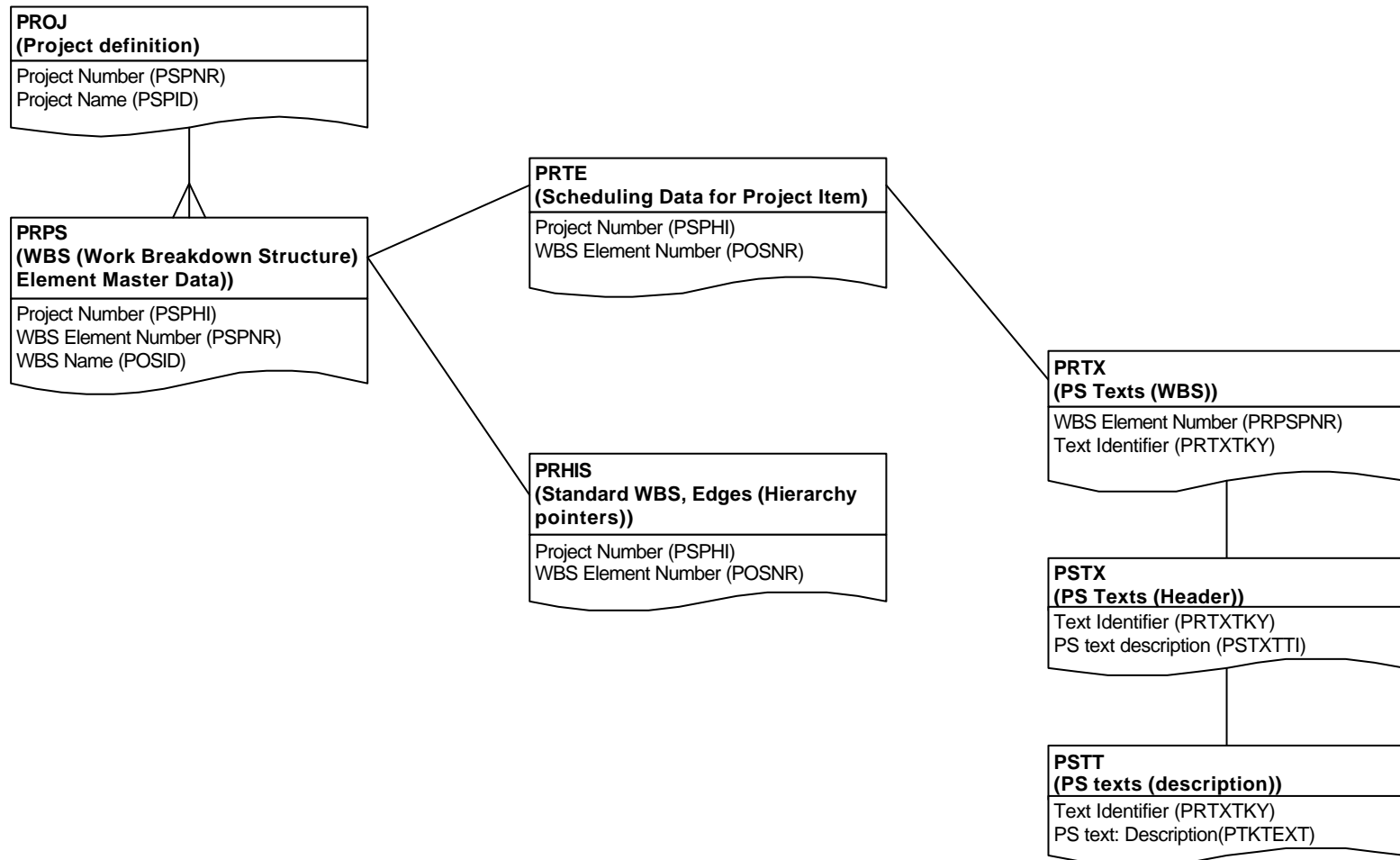

SAP - Sales and Distribution

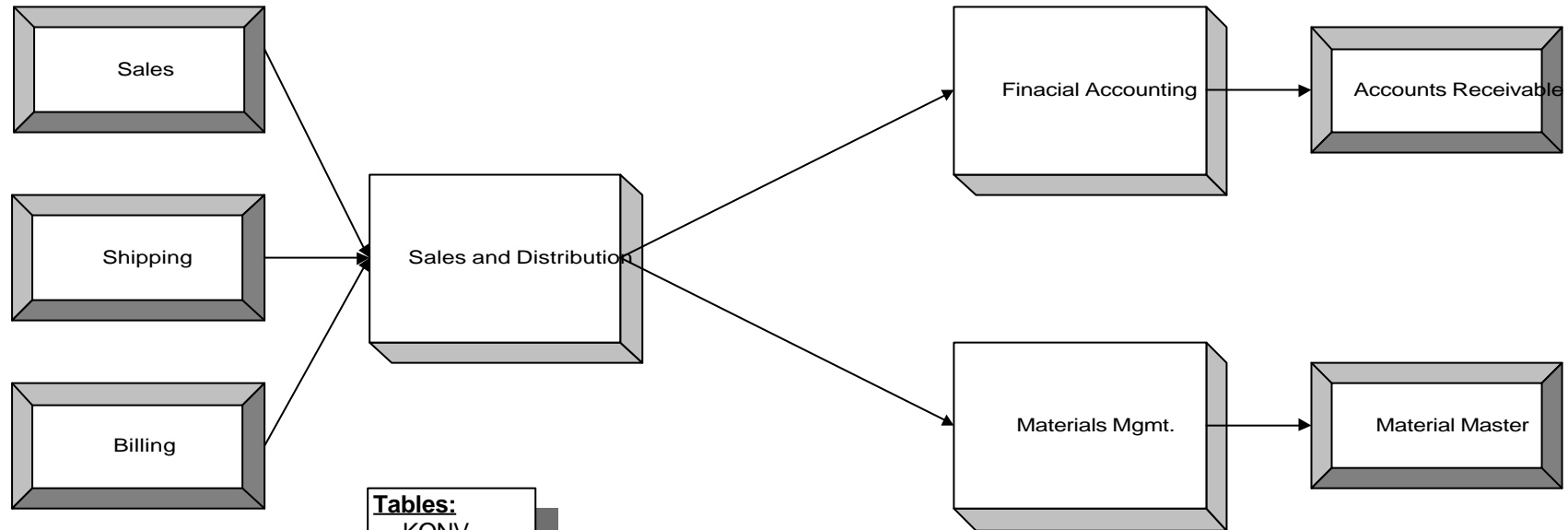

Tables:

KONV
LIKP
LIPS
VBAK
VBAP
VBBE
VBEH
VBEP
VBFA
VLB
VBLK
VBPA
VBRK
VBRP
VBUK
VBUP
VEKP
VEPO
VEPVG

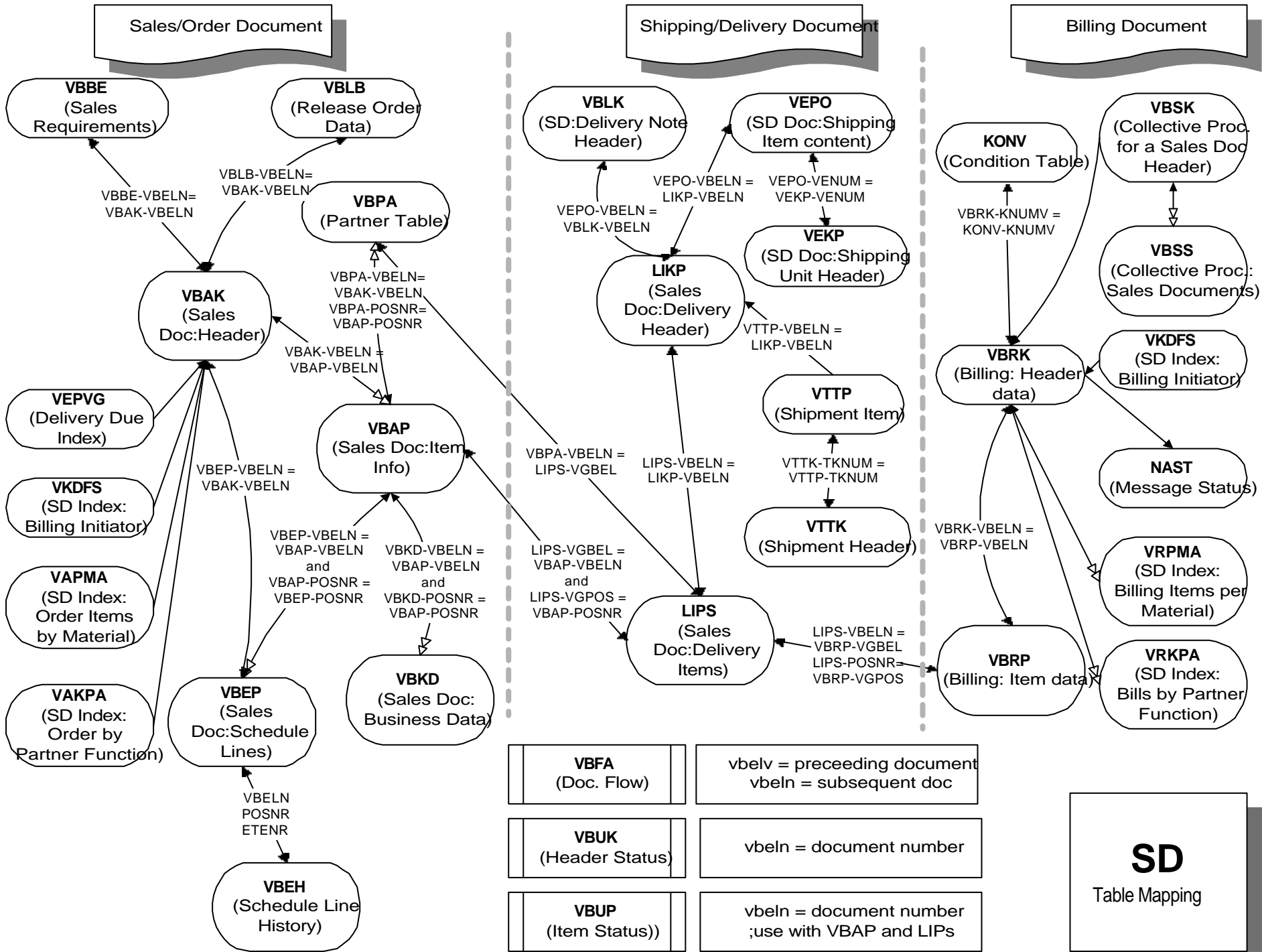

SAP SD - Sales Tables

VKDFS (SD Index: Billing Initiator)
Billing Cat (FKTYP) Sales Org (VKORG) Billing Date (FKDAT) Customer (KUNNR) Billing Type (FKART) Country (LLAND) Sales doc (VBELN)

VAPMA (SD Index: Order Items by Material)
Material No (MATNR) Sales Org (VKORG) Trans Group (TRVOG) Document Date (AUDAT) Distribution Channel (VTWEG) Division (SPART) Document Type (AUART) Sold-to-Party (KUNNR) Sales Office (VKBUR) Sales Group (VKGRP) Customer PO No (BSTNK) User Name (ERNAM) Sales Ord (VBELN) Item (POSNR)

VAKPA (SD Index: Order by Partner Function)
Partner No (KUNDE) Partner Function (PARVW) Sales Org (VKORG) Trans Group (TRVOG) Document Date (AUDAT) Sales Office (VKBUR) Sales Group (VKGRP) Distribution Channel (VTWEG) Division (SPART) Document Type (AUART) Customer PO No (BSTNK) Sold-to-Party (KUNNR) User Name (ERNAM) Sales Ord (VBELN)

STXH (STXD SAPscript text file header)
Texts (TDOBJECT) Text Name (TDNAME) Text Id (TDID) Language (TDSPRAS)

STXL (STXD SAPscript text file lines)
(RELID) Texts (TDOBJECT) Text Name (TDNAME) Text Id (TDID) Language (TDSPRAS) (SRTF2)

VBUK (Header Status)
Sales doc (VBELN)

VBAK (Sales Document : Header)
Sales doc (VBELN)

VBFA (Sales Document Flow)
Preceding Sales Doc (VBELV) Preceding Item (POSNV) Subsequent Sales doc (VBELN) Subsequent Item (POSNN) Document Cat (VBTP_N)

VBUP (Item Status)
Sales doc (VBELN) Item (POSNR)

VBAP (Sales Document : Item Info)
Sales doc (VBELN) Item (POSNR)

To Shipping through LIPS
LIPS-VGBEL = VBAP-VBELN
and
LIPS-VGPOS = VBAP-POSNR

VBEP (Sales Document : Schedule Lines)
Sales doc (VBELN) Item (POSNR) Schedule Line (ETENR)

VBKD (Sales Document : Business Data)
Sales doc (VBELN) Item (POSNR)

VBEH (Schedule Line History)
Sales doc (VBELN) Item (POSNR) Schedule Line (ETENR)

VBPA (Sales Document : Partner)
Sales doc (VBELN) Item (POSNR) Partner Function (PARVW)

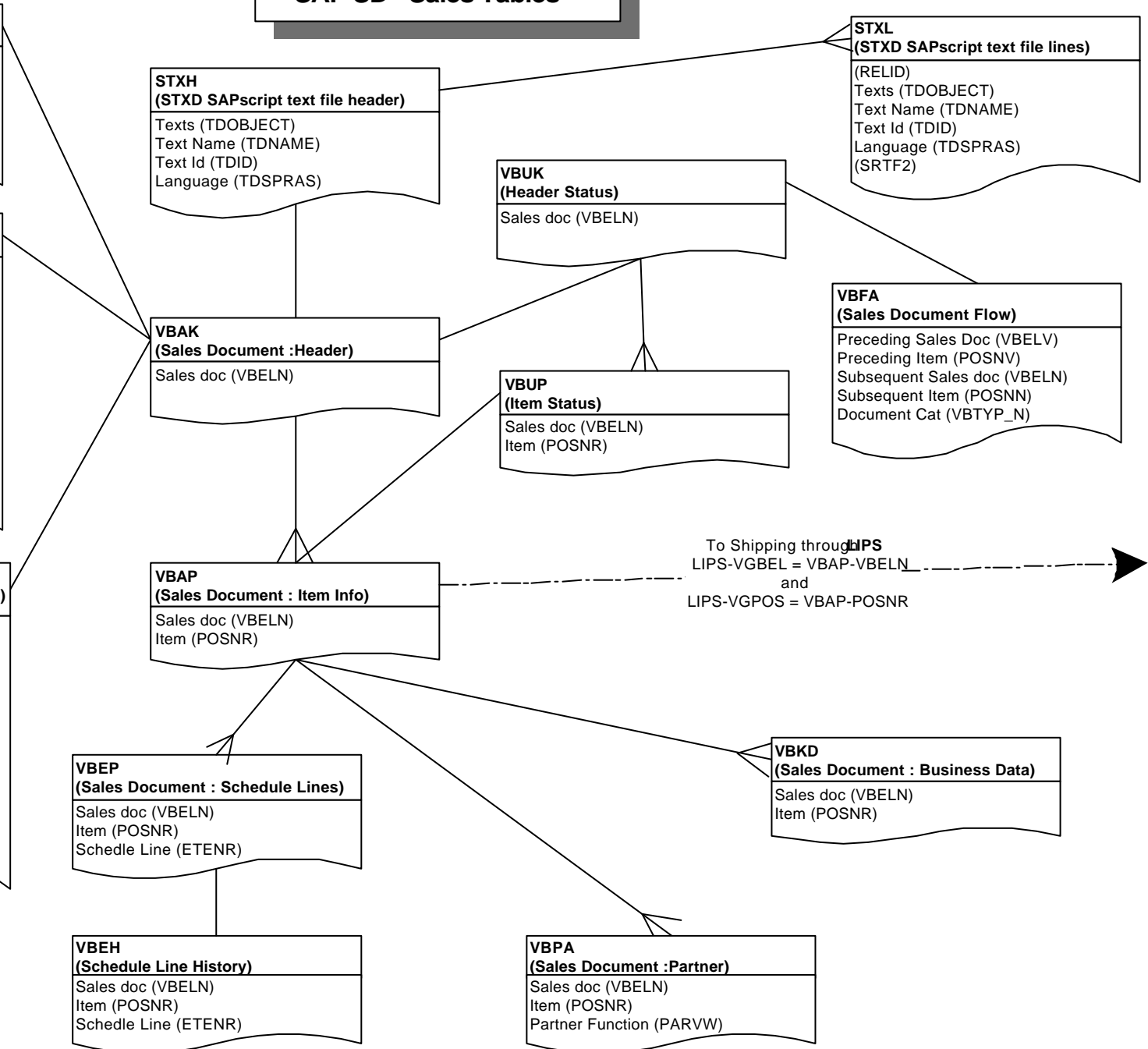

SAP SD - Shipping Tables

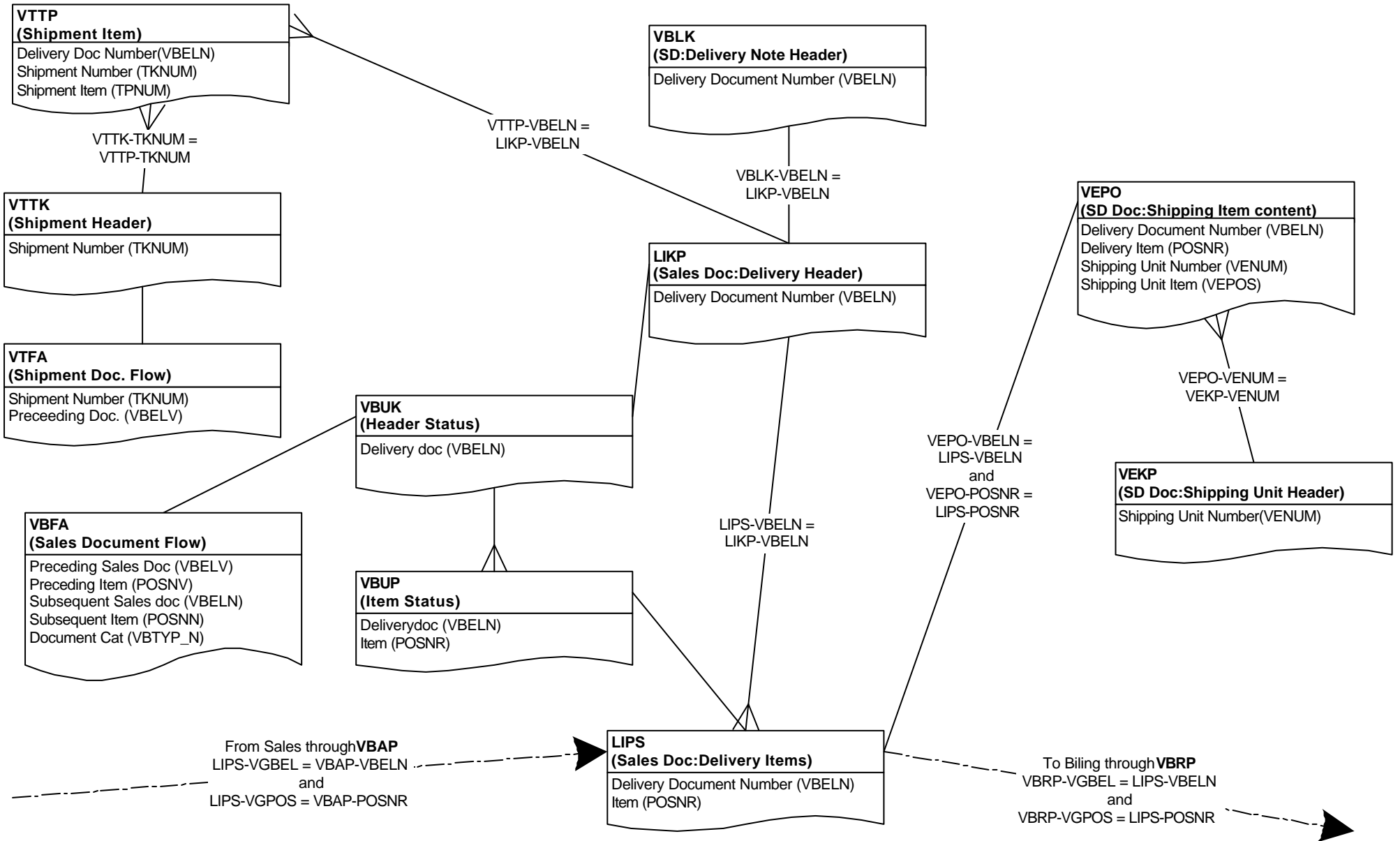

SAP SD - Billing Tables

VRKPA (Sales Index: Bills by Partner Functions)
Partner No (KUNDE) Partner Function (PARVW) Sales Org (VKORG) Billing Date (FKDAT) Distribution Channel (VTWEG) Billing Type (FKART) Payer (KUNNR) Sold-to-Party (KUNNR) SD Doc Cat (VBTYP) User Name (ERNAM) Billing Doc (VBELN)

VKDFS (SD Index: Billing Initiator)
Billing Cat (FKTYP) Sales Org (VKORG) Billing Date (FKDAT) Customer (KUNNR) Billing Type (FKART) Country (LLAND) Sales doc (VBELN)

VBSK (Collective Processing for a Sales Document Header)
Grouped Delivery (SAMMG)

VBSS (Collective Processing: Sales Documents)
Grouped Delivery (SAMMG) Sales doc (VBELN)

VRPMA (SD Index: Billing Items per Material)
Material No (MATNR) Sales Org (VKORG) Billing Date (FKDAT) Distribution Channel (VTWEG) Billing Type (FKART) Payer (KUNNR) Sold-to-Party (KUNNR) SD Doc Cat (VBTYP) User Name (ERNAM) Billing Doc (VBELN) Item (POSNR)

VBRK (Billing: Header Data)
Billing doc (VBELN)

NAST (Billing: Header Data)
Application (KAPPL) Object (OBJKY) Output Type (KSCHL) Language (SPRAS) Mess Partner (PARNR) Partner Func (PARVW) Date (ERDAT) Time (ERUHR)

VBUK (Header Status)
Sales doc (VBELN)

VBRP (Billing: Item Data)
Billing doc (VBELN) Item (POSNR)

VBUP (Sales Document: Item Status)
Sales doc (VBELN) Item (POSNR)

VBFA (Sales Document Flow)
Preceding Sales Doc (VBELV) Preceding Item (POSNV) Subsequent Sales doc (VBELN) Subsequent Item (POSNN) Document Cat (VBTYP_N)

From Shipping through
 VBRP-VGBEL = LIPS-VBELN
 and
 VBRP-VGPOS = LIPS-POSNR

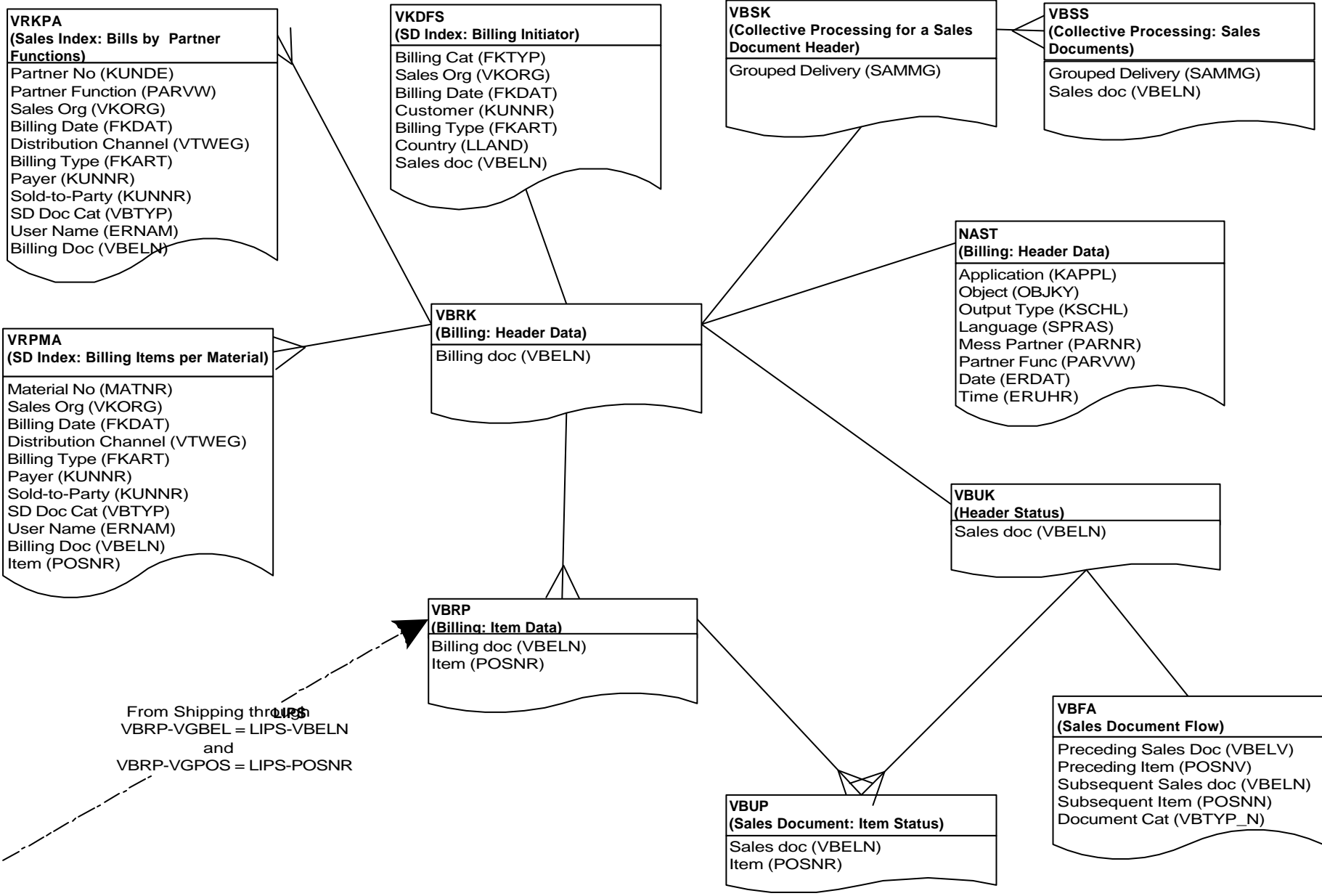

SAP SD - Links to FI Tables

Customer Master Data

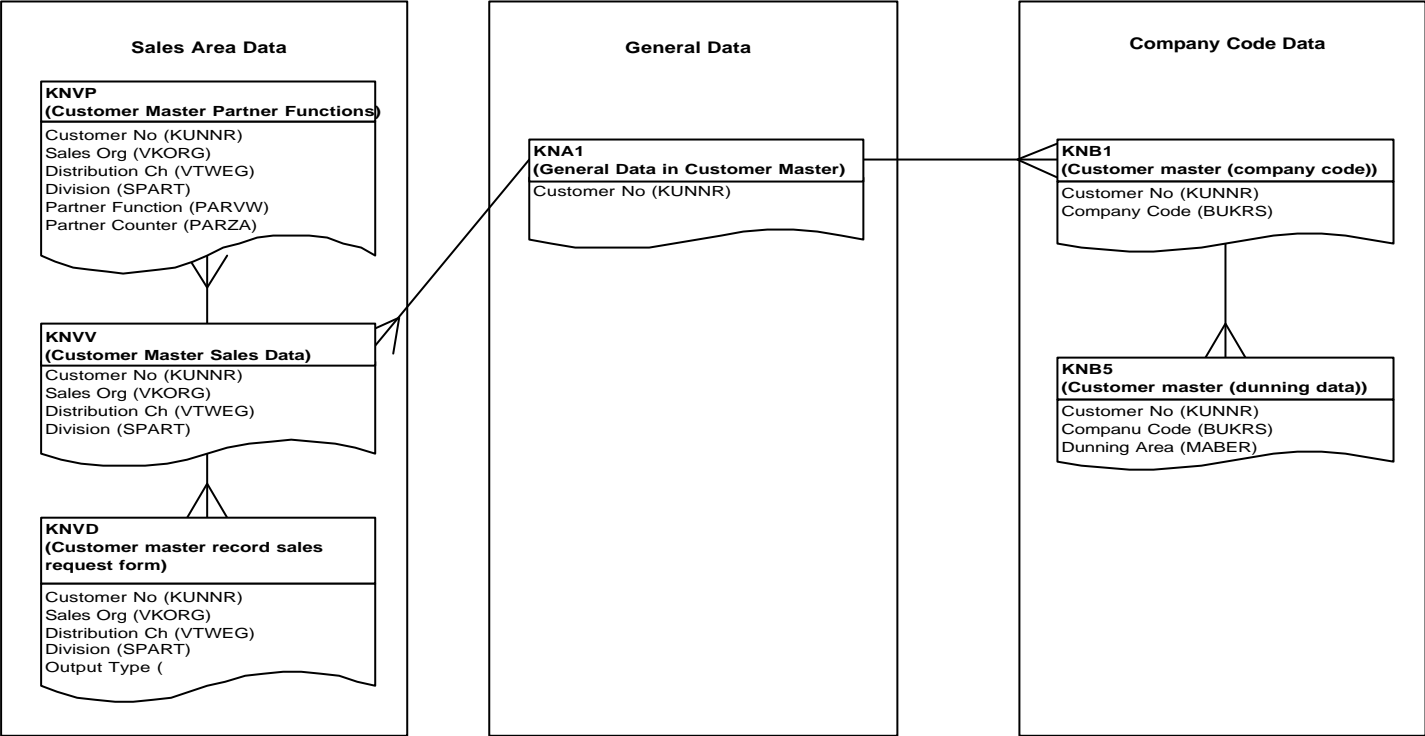

SAP SD - Links to MM Tables

Material Master Data

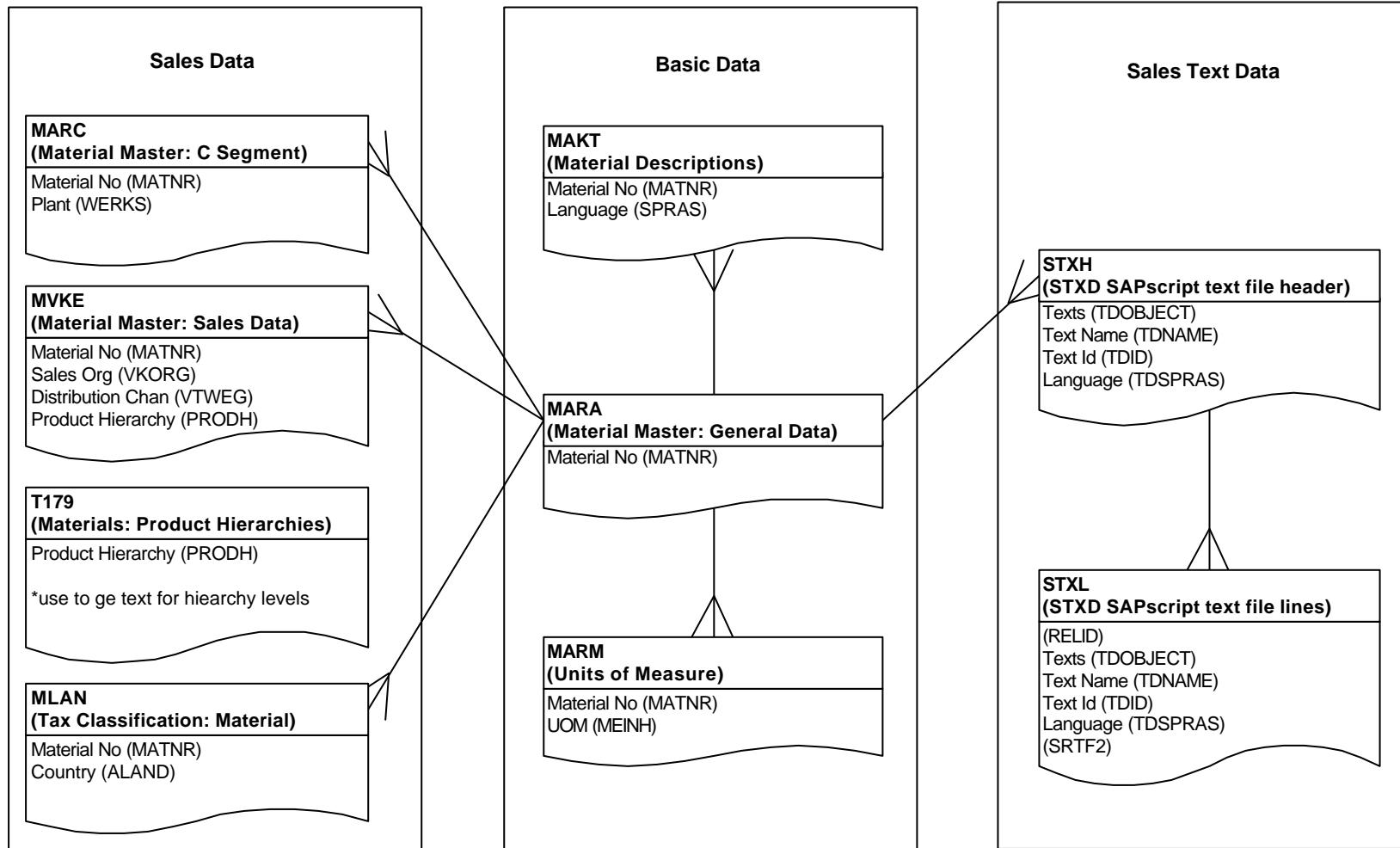

Contributions by

Master Data

Jim Lewis (Whittman-Hart, inc.)

FI/CO

Michael Rhodes (MedPartners, inc.)

HR

MM

Jim Lewis (Whittman-Hart, inc.)
Michael Rhodes (MedPartners, inc.)

PP

SD

Paul Evans (Whittman-Hart, inc.)
Krishna Prasad (Whittman-Hart, inc.)
Russ Smith (Benteler)
Michael Rhodes (MedPartners, inc.)